

1.8m, Ultra High Performance, Single-Polarized, 5.925-7.125GHz

Electrical Specifications	
Frequency (GHz)	5.925-7.125
Polarization	Single (V or H)
Gain, Low (dBi)	38.5
Gain, Mid (dBi)	39.4
Gain, Top (dBi)	39.4
Beam Width (deg)	1.7
Cross-pol. Discrimination_XPD (dB)	30
F/B Ratio (dB)	65
VSWR (max)	1.3
Regulatory Compliance	ETSI EN 302 217-4-2 V 1.5.1 Range 1, Class 3

Mechanical Specifications	
Diameter (m)/ft.	1.8m/6 ft.
Antenna Color	Cool Gray
Wave-guide Size	153 IEC-R70
Radome Options	Flexible
Azimuth Adjustment	Coarse : 360° Fine : ±5°
Elevation Adjustment	Coarse : ±5° Fine : ±5°
Diameter of Mounting Pole (mm)	Φ114
Wind Velocity Survival Rating (m/s)	67
Wind Velocity Operational (m/s)	30
Ice-load (mm)	25.4
Operational Temperature (°C)	-45 ~ +60
Axial Force (N)	9758
Side Force (N)	4816
Twisting Moment (N•m)	2728
Packaging	Wooden
L×W×H (mm)/ft.	2100x570x2200 / 6.10'x1.8'x7.2'
Gross Weight/Net Weight/GW #/NW#	154kg/83kg / 339lb./183lb.

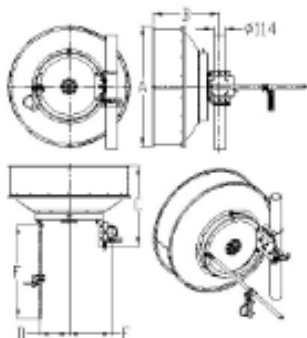

Dimensions (mm)	
A	1877
B	1044
C	265
D	367
E	1955

Radio/Mount	Code
Remec	
Rectangular	01
Remec Round	02
Dragonwave	03
Exalt	04
Solectek	05
Ceregon	06
Bridgewave	07