

1.2m, Ultra High Performance, Dual-Polarized, 21.2-23.6GHz

Electrical Specifications	
Frequency (GHz)	21.2-23.6
Polarization	Dual (V or H)
Gain, Low (dBi)	45.6
Gain, Mid (dBi)	46.3
Gain, Top (dBi)	46.6
Beam Width (deg)	0.8
Cross-pol. Discrimination_ XP D (dB)	30
F/B Ratio (dB)	74
VSWR (max)	1.3
Regulatory Compliance	ETSI EN 302 217-4-2 V 1.5.1 Range 2, Class 3

Mechanical Specifications	
Diameter (m)/ft.	1.2m/4 ft.
Antenna Color	Cool Gray
Wave-guide Size	153 IEC-R220
Radome Options	Molded
Azimuth Adjustment	Coarse : 360° Fine : ±10°
Elevation Adjustment	Coarse : ±10° Fine : ±10°
Diameter of Mounting Pole (mm)	Φ114
Wind Velocity Survival Rating (m/s)	67
Wind Velocity Operational (m/s)	30
Ice-load (mm)	25.4
Operational Temperature (°C)	-45 ~ +60
Axial Force (N)	4008
Side Force (N)	1978
Twisting Moment (N•m)	1759
Packaging	Wooden
L×W×H (mm)/ft.	1380x450x1700 / 4.52'x1.48'x5.58'
Gross Weight/Net Weight/GW #/NW#	74kg/44kg / 163.14#/97#

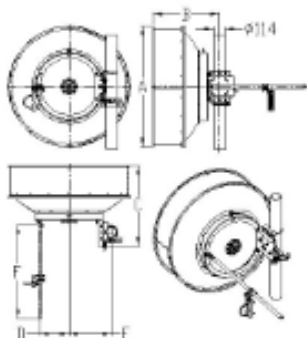

Dimensions (mm)	
A	1228
B	689
C	834
D	299
E	439
F	1470

Radio/Mount	Code
Remec	
Rectangular	01
Remec Round	02
Dragonwave	03
Exalt	04
Solectek	05
Ceregon	06
Bridgewave	07