

## 0.6m, Ultra High Performance, Dual-Polarized, 24.25-26.5GHz

### Electrical Specifications

Frequency (GHz)	24.25-26.5
Polarization	Dual (V or H)
Gain, Low (dBi)	40.7
Gain, Mid (dBi)	41.2
Gain, Top (dBi)	41.7
Beam Width (deg)	1.5
Cross-pol. Discrimination_ XP D (dB)	30
F/B Ratio (dB)	68
VSWR (max)/ISO. (dB)	1.3 / 35
Regulatory Compliance	ETSI EN 302 217-4-2 V 1.5.1 Range 4, Class 3

### Mechanical Specifications

Diameter (m)/(ft)	0.6m/2ft
Antenna Color	Pantone Cool Gray 1C
Wave-guide Size	153 IEC-R220
Radome Options	Molded
Azimuth Adjustment	Coarse : 360° Fine : ±15°
Elevation Adjustment	Coarse : ±25° Fine : ±15°
Diameter of Mounting Pole (mm)/(in)	Φ51~Φ114mm/2~4.5in
Wind Velocity Survival Rating (m/s)	67
Wind Velocity Operational (m/s)	30
Ice-load (mm)/(in)	25.4mm/1in
Operational Temperature (°C) / (°F)	-45~+60°C / -49~140°F
Axial Force (N)	1218
Side Force (N)	601
Twisting Moment (N•m)	505
Packaging	Carton
L×W×H (mm)/(in)	750x750x440mm/29.5x29.5x17in
Gross Weight/Net Weight (kg) / (lb)	16kg/11kg/35lb/24lb

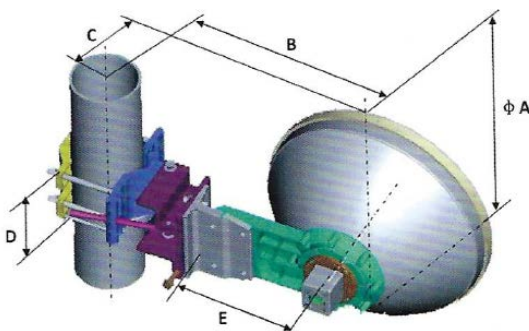

Dimensions (mm)	
A	657
B	412
C	265
D	115
E	232
F	NA

Radio Mount Chart	Code
Remec Rectangular	01
Remec Round	02
Dragonwave	03
Exalt	04
Solectek	05
Ceregon	06
Bridgewave	07