

0.3m, Ultra High Performance, Dual-Polarized, 40.5-43.5GHz

Electrical Specifications

Frequency (G Hz)	40.5-43.5
Polarization	Dual (V or H)
Gain, Low (dBi)	39.9
Gain, Mid (dBi)	40.3
Gain, Top (dBi)	40.6
Beam Width (deg)	1.5
Cross-pol. Discrimination_XP D (dB)	30
F/B Ratio (dB)	60
VSWR (max)	1.3
Regulatory Compliance	ETSI EN 302 217-4-2 V 1.5.1 Range 5, Class 3

Mechanical Specifications

Diameter (m)/(ft)	0.3m /1ft
Antenna Color	Pantone Cool Gray 1C
Wave-guide Size	153 IEC-R320
Radome Options	Molded
Azimuth Adjustment	Coarse : 360° Fine : ±15°
Elevation Adjustment	Coarse : ±25° Fine : ±15°
Diameter of Mounting Pole (mm)/(in)	Φ51~Φ114mm/ 2~4.5in
Wind Velocity Survival Rating (m/s)	67
Wind Velocity Operational (m/s)	30
Ice-load (mm)/(in)	25.4mm / 1in
Operational Temperature (°C)/(°F)	-45~+60 °C / -49~140 °F
Axial Force (N)	407
Side Force (N)	201
Twisting Moment (N•m)	168
Packaging	Carton
L×W×H (mm)/(in)	500x450x320mm/19.5x19.5x12.5 in
Gross Weight/Net Weight (kg)/(lb)	8.5kg/6.5kg/18.5lb/14lb

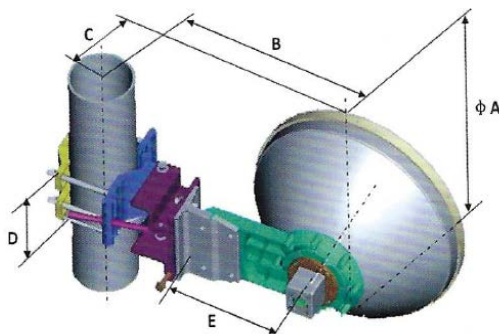

Dimensions (mm)	
A	375
B	412
C	145
D	115
E	232
F	NA

Radio Mount Chart Code

Remec Rectangular	01
Remec Round	02
Dragonwave	03
Exalt	04
Solectek	05
Ceregon	06
Bridgewave	07